

MS7015 v3

DIMENSIONS [mm]

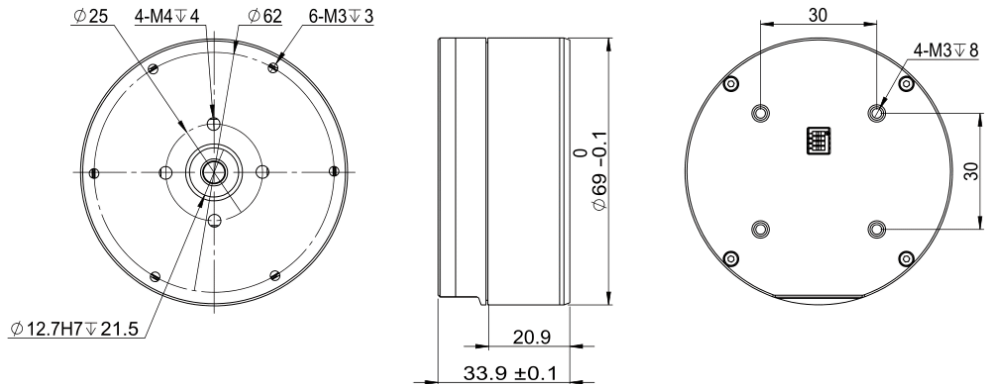

Weight : 360g approx.



MOTOR DATA

Outer Rotor Brushless DC Motor

1	Nominal Voltage	VDC	24
2	Nominal Torque	Nm	0.8
3	Nominal Speed	rpm	140
4	Nominal Current	A	1.2
5	Max Speed	rpm	300
6	Max Torque	Nm	1.6
7	Max Current	A	2.35
8	Max Output Power	W	11.8
9	Speed Constant	rpm/V	13.1
10	Torque Constant	Nm/A	0.7
11	Winding Type		Y
12	Number of Winding Turns		60
13	Resistance (phase to phase)	Ω	7.5
14	Inductance (phase to phase)	mH	3.7
15	Number of Poles		28
16	Rotor Inertia	gcm ²	933
17	Working Temperature	°C	-20~+80
18	Bearing Nominal Load	N	330

DRIVER DATA

32-bit MCU / SVPWM Control / Trapezoidal Acceleration

19	Input Voltage	VDC	7.4~24
20	Output Current	A	Nominal 4 / Max 6
21	Encoder		15-bit or 18-bit Absolute Angle-sensing Magnetic Encoder
22	Communication		RS485 or CAN
23	Communication Frequency	Hz	RS485 : 500 / CAN : 2000 (based on default baud rate)
24	RS485 Baud Rate	bps	9.6K, 19.2K, 38.4K, 57.6K, 115.2K(default), 230.4K, 460.8K, 1M, 2M
25	CAN Baud Rate	bps	125K, 250K, 500K, 1M(default)
26	Control Cycle		Open Loop 24KHz / Speed Loop 8KHz / Position Loop 8KHz

DRIVER INTERFACE PIN ASSIGNMENT

Pin --- B / L	RS485 - B / CAN - L
Pin --- A / H	RS485 - A / CAN - H
Pin --- V-	Power Supply - Negative
Pin --- V-	Power Supply - Negative
Pin --- V-	Power Supply - Negative
Pin --- V+	Power Supply - Positive
Pin --- V+	Power Supply - Positive
Pin --- V+	Power Supply - Positive
Pin --- T	UART Transmitter
Pin --- R	UART Receiver
Pin --- G	Signal GND

MS7015 v3

CHARACTERISTIC CURVE

— Input Current — Efficiency — Output Power — Output Torque

